

Features

- \varnothing 1900 μm active area
- High QE for $\lambda = 350\text{-}750$ nm
- Low noise
- Fast rise time

Description

Circular active area APD chip with blue enhanced sensitivity. Metal can type hermetic TO5i package with UV glass window.

Application

- Analytical equipment
- Scintillation
- Medical equipment
- High speed photometry

RoHS

2002/95/EC



Absolute maximum ratings

Symbol	Parameter	Min	Max	Unit
T_{STG}	Storage temp	-55	125	$^{\circ}\text{C}$
T_{OP}	Operating temp	-40	85	$^{\circ}\text{C}$
M_{max}	Gain ($I_{PO} = 1$ nA)	200		
I_{PEAK}	Peak DC current		0.25	mA

Spectral response (M = 100)

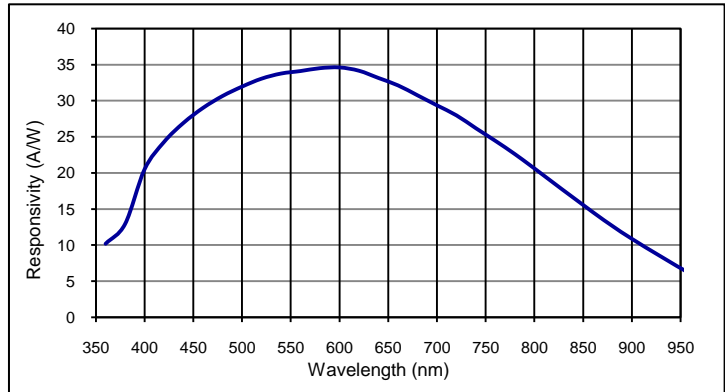

Schematic

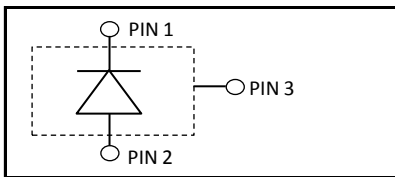

Electro-optical characteristics @ 23 $^{\circ}\text{C}$

Symbol	Characteristic	Test Condition	Min	Typ	Max	Unit
	Active area		diameter 1950			μm
	Active area		3.0			mm^2
I_D	Dark current	M = 100		5.0	20.0	nA
C	Capacitance	M = 100		10		pF
	Responsivity	M = 100; $\lambda = 410$ nm		22		A/W
	Responsivity	M = 100; $\lambda = 500$ nm		32		A/W
t_R	Rise time	M = 100; $\lambda = 410$ nm; $R_L = 50$ Ω		2		ns
	Cut-off frequency	-3dB		175		MHz
V_{BR}	Breakdown voltage	$I_R = 2$ μA , V_{BR} - binning available	90		240	V
	Temperature coefficient	Change of V_{BR} with temperature		0.88		V/K
	Excess noise factor	M = 100		2.0		
	Excess noise index	M = 100		0.15		

European, International Sales:



First Sensor AG
 Peter-Behrens-Strasse 15
 12459 Berlin
 Germany
 T +49 30 6399 2399
 F +49 30 639923-752
 sales.opto@first-sensor.com

USA:

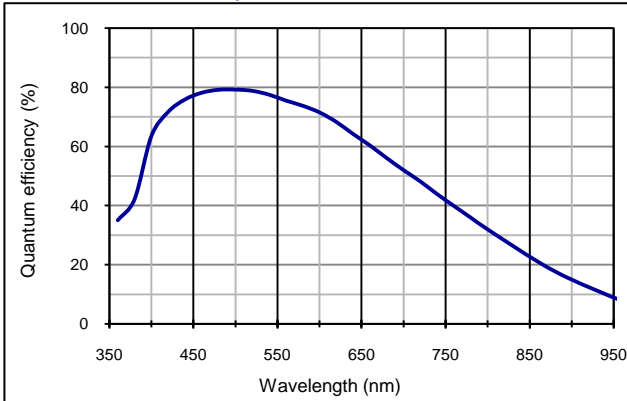
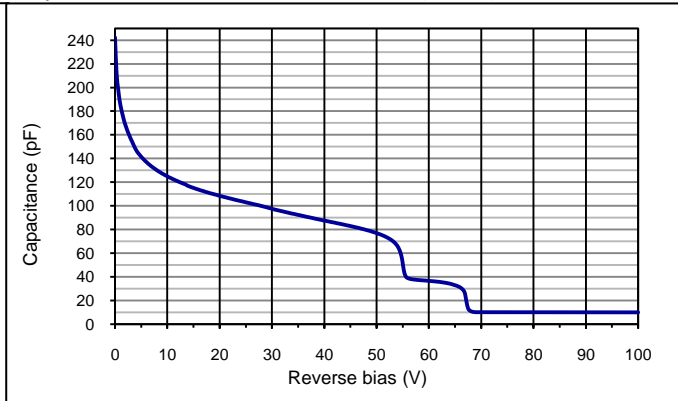
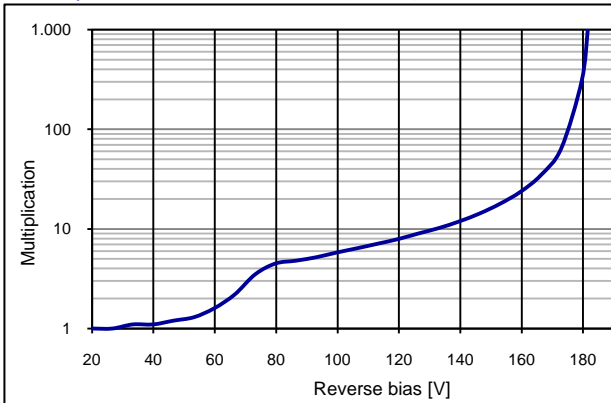
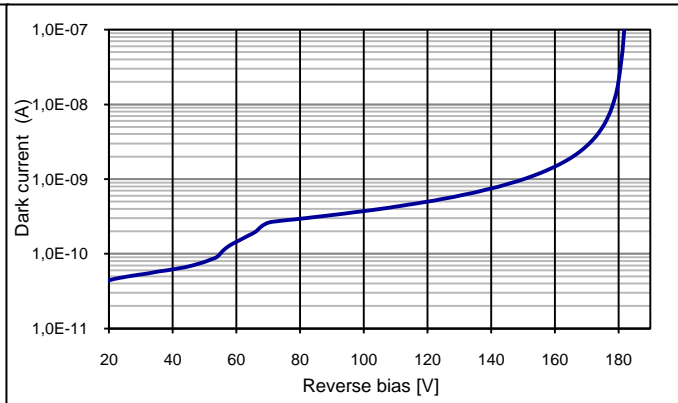
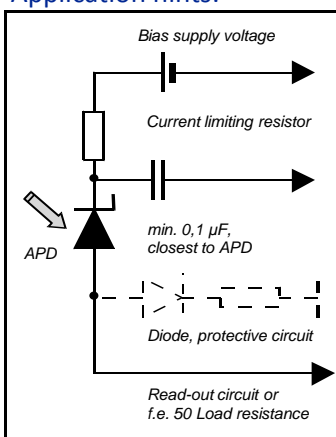

First Sensor Inc.
 5700 Corsa Avenue #105
 Westlake Village
 CA 91362 USA
 T +1 818 706 3400
 F +1 818 889 7053
 sales.us@first-sensor.com

Quantum efficiency (23 °C)

Capacitance as fct of reverse bias (23 °C)

Multiplication as fct of bias (23 °C)

Dark current as fct of bias (23 °C)

Application hints:

- Current should be limited by a protecting resistor or current limiting - IC inside the power supply
- For low light level applications blocking of ambient light should be used
- For high gain applications bias voltage should be temperature compensated
- Please consider basic ESD protection while handling
- Use low noise read-out - IC
- For further questions please refer to document "Instructions for handling and processing"
- Optimum gain: 50-80

Package dimension:

Small quantities: Foam pad, boxed (12 cm x 16.5 cm)

Disclaimer: Due to our strive for continuous improvement, specifications are subject to change within our PCN policy according to JESD46C.

European, International Sales:

First Sensor AG
 Peter-Behrens-Strasse 15
 12459 Berlin
 Germany
 T +49 30 6399 2399
 F +49 30 639923-752
 sales.opto@first-sensor.com

USA:

First Sensor Inc.
 5700 Corsa Avenue #105
 Westlake Village
 CA 91362 USA
 T +1 818 706 3400
 F +1 818 889 7053
 sales.us@first-sensor.com